

God enabled the Corinthian believers
to be blameless before Him.

Supply the missing letters in the verse, then
rearrange them to spell the missing word ...

Paul told them ...



“You do not la k

any spi itual ift

as you agerly

w it for our Lord.”

That was because of God’s

.

Paul reassured the Corinthians that God’s
power would keep them spiritually strong.

Find the right path through the maze.
Write the letters in order in the blanks to make words.
The number of letters in each word is given.

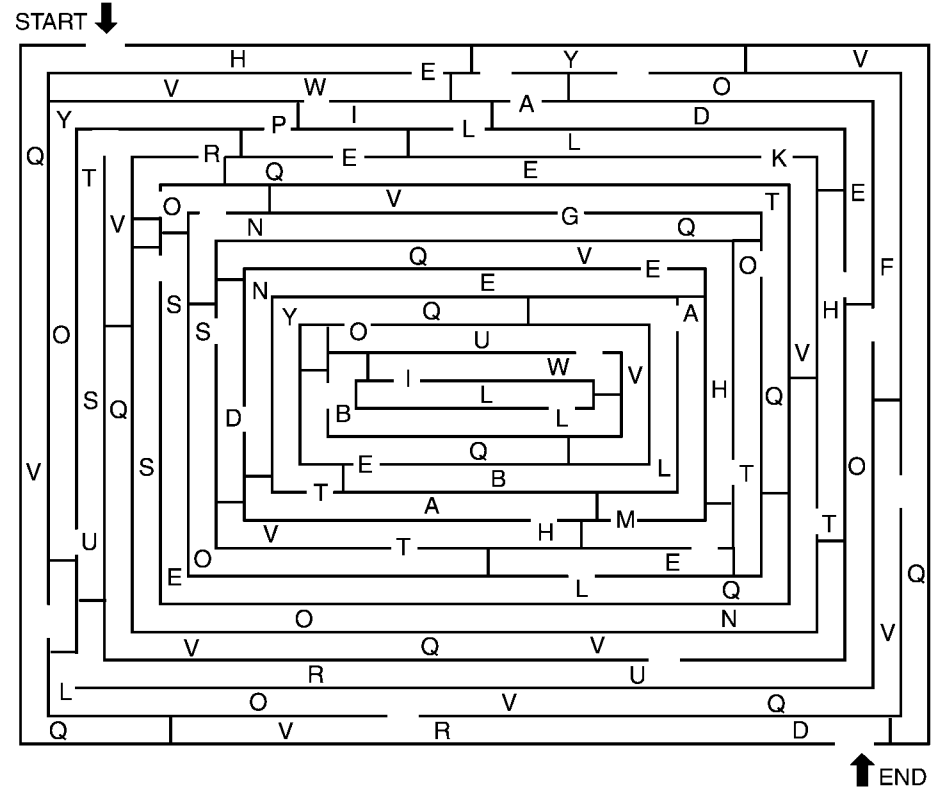

2	4	4	3	6	
2	3	3	2	4	3
4	2	9	2	3	
3	2	3	4		

God made Himself known to us in Jesus.

Match the people who are the same.

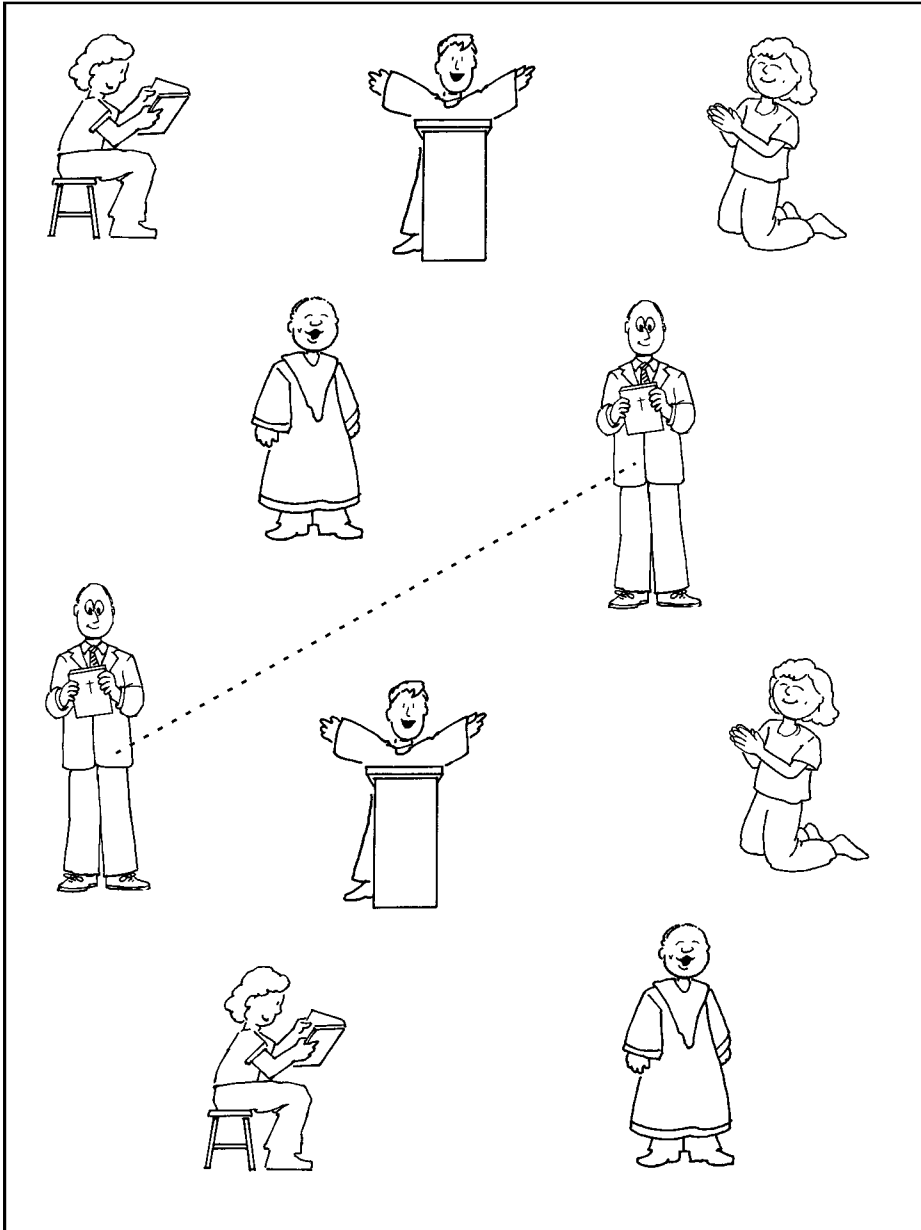

Children's Worship Bulletin™



Ages 3+

1 Corinthians 1:3-9

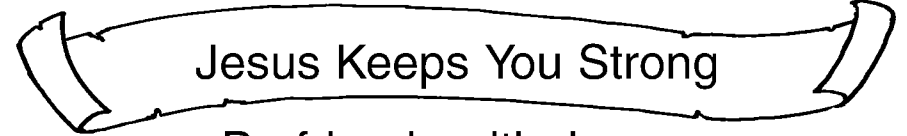

Be friends with Jesus.



Help the child find her way to Jesus.
1 2 3 4 5 6 7 8 9 10

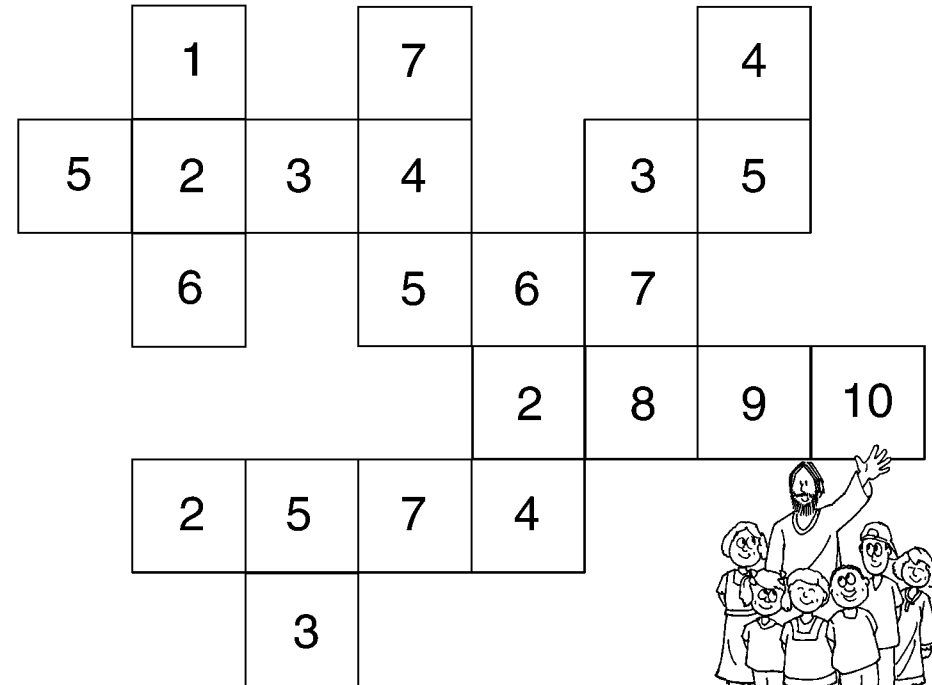

God will keep you ...

Use the code to fill in the letters.

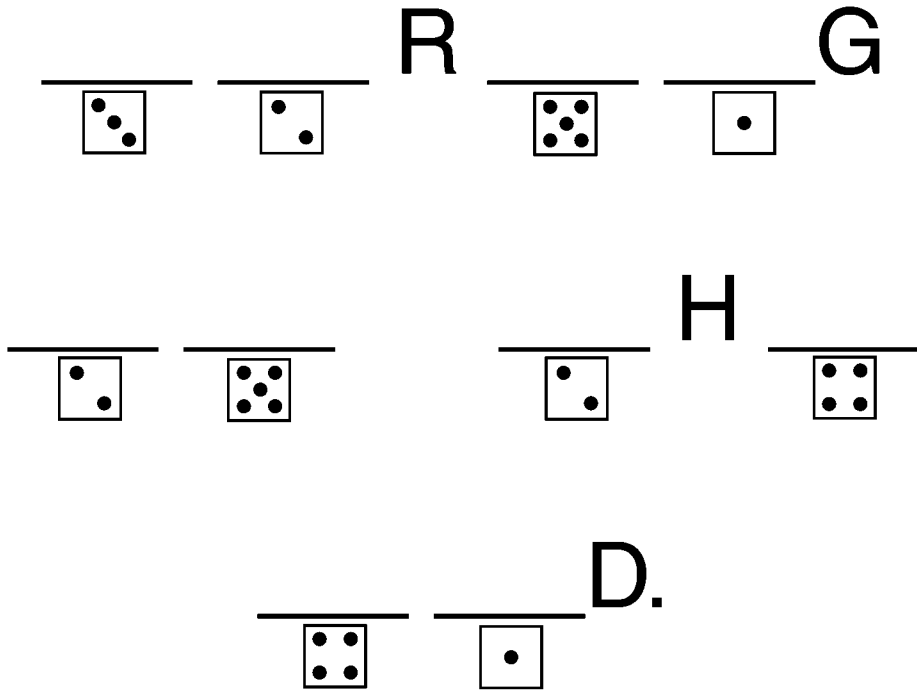
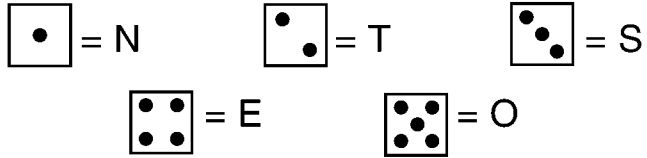

In Jesus our lives are better in every way.

Circle and find these objects.

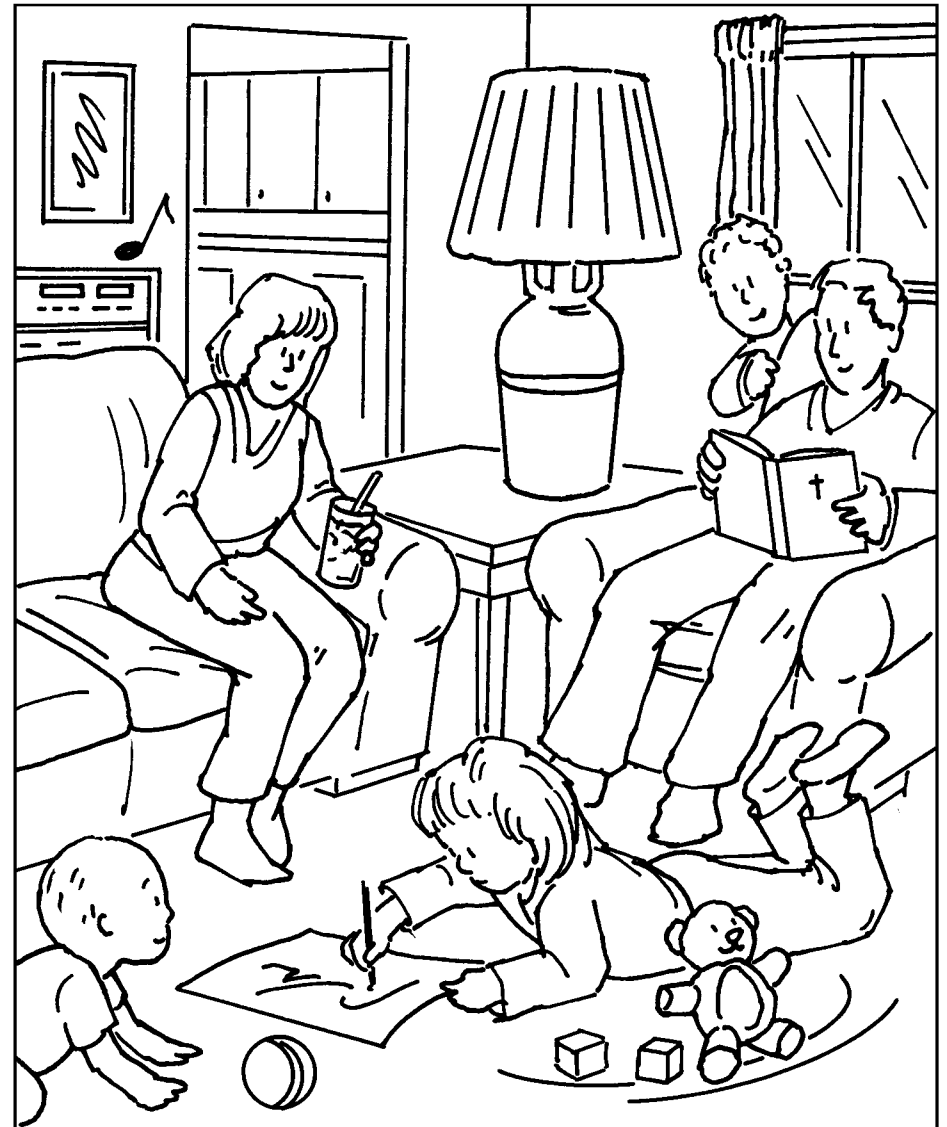



The Corinthians were comforted to know God would help them continue in righteousness.

Identify words Paul used to describe the Corinthians. Put a check mark (✓) before each word that contains any letters that are in the word CORINTHIAN.

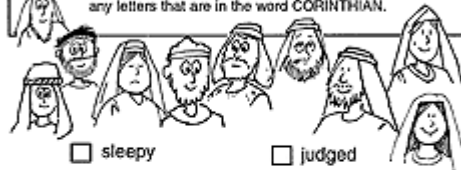

- | | |
|---|--|
| <input type="checkbox"/> sleepy | <input type="checkbox"/> judged |
| <input checked="" type="checkbox"/> blameless | <input type="checkbox"/> jumbled |
| <input type="checkbox"/> bubbly | <input type="checkbox"/> glum |
| <input checked="" type="checkbox"/> called | <input checked="" type="checkbox"/> kept |
| <input checked="" type="checkbox"/> confirmed | <input type="checkbox"/> numbskull |
| <input type="checkbox"/> dumb | <input checked="" type="checkbox"/> strong |
| <input checked="" type="checkbox"/> eager | <input type="checkbox"/> ugly |
| <input checked="" type="checkbox"/> enriched | <input type="checkbox"/> smug |
| <input type="checkbox"/> geeky | |

Children's Worship Bulletin™

Ages 7-12

March 22, 2020 • 1 Corinthians 1:3-9

Jesus Keeps You Strong

Paul told the Corinthians that ...

Unscramble each word to spell the name of one of the items that is pictured. Then use the circled letters to complete the sentence.



- infek..... k n i **ⓕ** e
 agpers..... g r **ⓐ** p e s
 minppuk..... p u m p k **ⓓ** n
 apell..... p l a **Ⓣ** e
 ihfs..... f i s **ⓓ**
 okrl..... **ⓕ** o r k
 tykeur..... t **Ⓚ** r k e y
 plape..... a p p **Ⓛ** e

God is f a i t h f u l.

God enabled the Corinthian believers to be blameless before Him.

Supply the missing letters in the verse, then rearrange them to spell the missing word ...

Paul told them ...



"You do not la**e**k
 any spi**r**itual **g**ift
 as you **e**agerly
 w**a**it for our Lord."

That was because of God's

G R A C E.

Paul reassured the Corinthians that God's power would keep them spiritually strong.

Find the right path through the maze. Write the letters in order in the blanks to make words. The number of letters in each word is given.

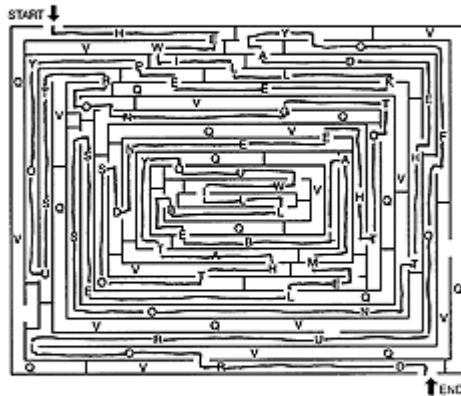

He₂ will₄ keep₄ you₃ strong₅
to₂ the₃ end₃ so₂ that₄ you₃
will₄ be₂ blameless₉ on₂ the₃
day₃ of₂ our₃ Lord₄.

Panel 4

God made Himself known to us in Jesus.

Match the people who are the same.

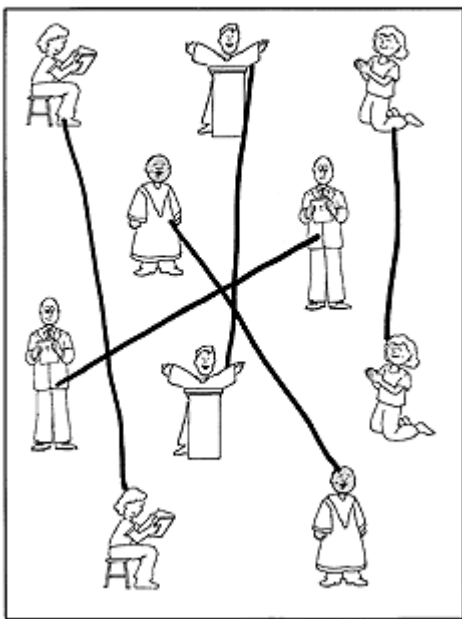

Panel 1

Children's Worship Bulletin

Ages 3-6 March 22, 2020 • 1 Corinthians 1:3-9

Jesus Keeps You Strong

Be friends with Jesus.

Help the child find her way to Jesus.
1 2 3 4 5 6 7 8 9 10

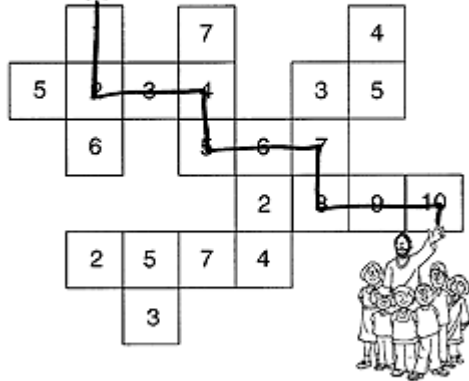

Panel 2

God will keep you ...

Use the code to fill in the letters.
 [1 dot] = N [2 dots] = T [3 dots] = S
 [4 dots] = E [5 dots] = O

S T R O N G
 T O T H E
 E N D.



Panel 3

In Jesus our lives are better in every way.

Circle and find these objects.

